

LSAIM04-1-R AI module

LS communication Thermocouple inputs : 7 -20 to 80 mV

■ Summary

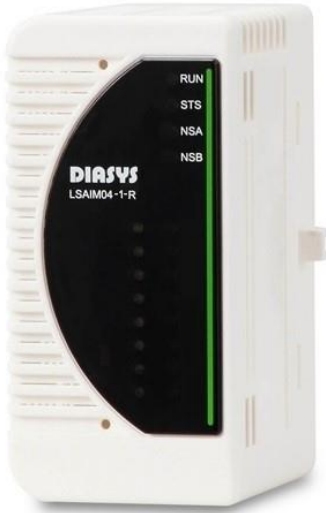

- * Number of inputs : 7 /Thermocouple input
(+1 /Cold junction compensation input ,
Channel individual isolation)
- * Input range : -20 to 80 mV
- * Module ambient temperature : 0 to 55°C
- * Insulation method : Photocoupler insulation
- * Supported FXtoLS adapter : LSRLTS-AI01, LSRLTS-AI04



This module is dedicated to compact retrofit terminal blocks.
Dedicated lock pins are attached to the bottom.

LAIM04-1-R AI module

LS communication Thermocouple inputs : 7 -20 to 80 mV

■ Specifications

ITEM		SPECIFICATION	
Input	Number of channels	7 points +1 point cold junction compensation (channel individual isolation)	
	Resolution	16 bits	
	Burnout Upscale/Downscale	Switchable by EMS setting	
	Range *1	-20 to 80 mV (Full Scale)	
	TC	T: -200 to 400°C , -5.603 to 20.872 mV J: -200 to 1200°C , -7.890 to 69.553 mV E: -200 to 1000°C , -8.825 to 76.373 mV R: -50 to 1768°C , -0.226 to 21.101 mV K: -200 to 1372°C , -5.891 to 54.886 mV	
Absolute accuracy @25°C	RTD	PT100: -10 to 100°C , 96.09 to 138.51 Ω (Full Scale)	
	mV	- ±0.1%FS (mV input)	
	TC	Type-T	±4°C (<-150°C), ±1°C (-150°C~400°C)
		Type-J	±4°C (<-150°C), ±1°C (-150°C~1200°C)
		Type-E	±4°C (<-150°C), ±1°C (-150°C~1000°C)
Type-R		±4°C (<0°C), ±3°C (0°C~200°C), ±2°C (>200°C)	
Type-K	±4°C (<-150°C), ±1°C (-150°C~1372°C)		
RTD	Type-PT100	±0.1°C	
Temperature drift @-5°C to 60°C	TC	Less than ±100 ppm/°C (relative to full-scale)	
	RTD	Less than ±100 ppm/°C (relative to full-scale)	
CMRR	TC	Type-E	100 dB or more attenuation
		Type-T	100 dB or more attenuation
	RTD	When voltage	100 dB or more attenuation
		When Current	100 dB or more attenuation
NMRR	TC	20 dB or more attenuation	
	RTD	20 dB or more attenuation	
Data refresh cycle		50 ms /All channels	
Input filter		Software digital filter (Channel individual)	
Dielectric strength		AC 500 V input terminal – between PE Between input channels	
Communication with IOA	Communication method	LVDS	
	Communication speed	100 Mbps	
Self-diagnostic functions		Power voltage check (24 V, 3.3 V, 2.5V, 1.8V, 1.0 V) Clock check (FPGA-MCU for diagnosis, MCU for diagnosis -FPGA) Heartbeat check (FPGA-MCU for diagnosis, MCU for diagnosis -FPGA) CRC check (FPGA) AI communication error check	
Detective		ADC abnormal check I/O signal range check (Overrange, Underrange) *1	
Operation at disconnection		1 to 7 ch (For upscale burnout setting) Detect overrange 1 to 7 ch (For downscale burnout setting) Detect underrange 8 ch Simultaneous detection of underrange and overrange	
Protection (Power supply protection)		Overvoltage protection Overcurrent protection	
Indicator Display LED		4: RUN (Run) / STS (Status) / NSA (Network status A) / NSB (Network status B)	
Insulation method		Photocoupler insulation	
Hot swap		Possible	
Power supply		DC 24 V ±20% (The voltage supplied from the backplane)	
Environmental conditions	Module ambient temperature	(Operating) 0 to 55°C (Storage) -40 to 85°C	
	Module ambient humidity	(Operating / Storage) Less than 95% RH (No condensation)	
Vibration		3.5 mm @5 to 8.4 Hz 1 G @8.4 to 150 Hz	
Shock		15 G 11 ms	
Current consumption		Less than 82 mA	
Weight		0.12 kg	
Dimensions		62 mm (D) x 94 mm (H) x 46 mm (W) (Except projection)	
Standard/Directive		EN 61131-2:2007, RoHS	

LSAIM04-1-R AI module

LS communication Thermocouple inputs : 7 -20 to 80 mV

*¹ Input Overrange / Input Underrange are detected under the following conditions.

- Type-E: Less than -270°C (-9.835mV) / More than 1000°C (36.373mV)
- Type-J: Less than -210°C (-8.095mV) / More than 1200°C (69.553mV)
- Type-K: Less than -270°C (-6.458mV) / More than 1370°C (54.819mV)
- Type-R: Less than -50°C (-0.226mV) / More than 1760°C (21.003mV)
- Type-T: Less than -270°C (-6.258mV) / More than 400°C (20.872mV)
- Pt100 : Less than -12.77°C (95.000Ω) / More than 103.072°C (139.670Ω)

LAIMO4-1-R AI module

LS communication Thermocouple inputs : 7 -20 to 80 mV

Block diagram

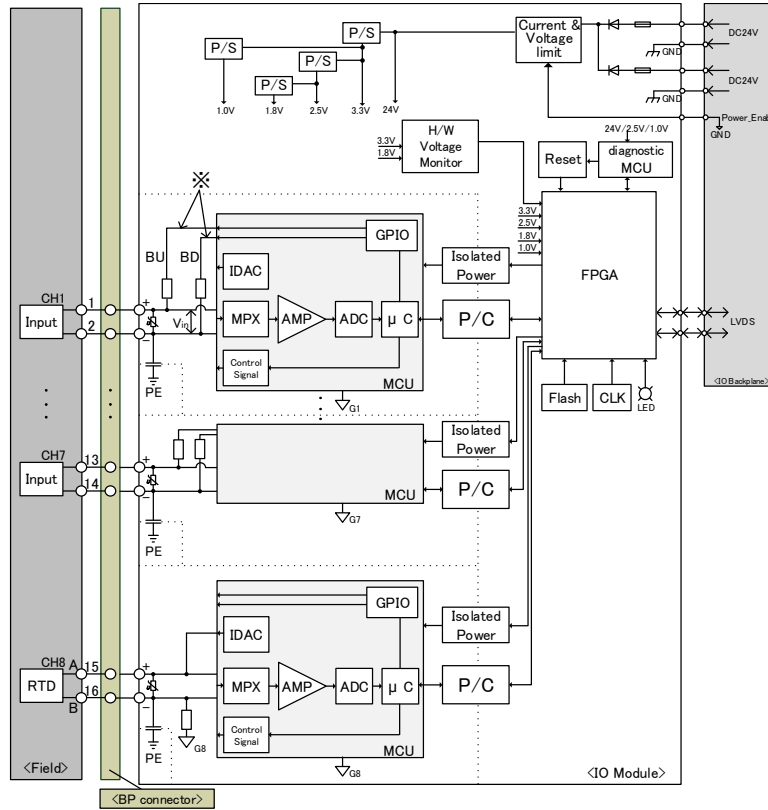





*

The setting of burnout direction, upscale / downscale, is determined by which side of + side / - side is made High.

-Normal time: The electromotive force of the compensation conductor is input to the MCU at Vin (+/- line voltage)

-At the time of disconnection (upscale burnout setting): the potential of the + side wiring rises ⇒
The value of Vin (the difference between the + side and the - side) becomes too large.
(The ADC input sticks to the upper limit) ⇒ Overrange

-At the time of disconnection (downscale burnout setting): the potential of the - side wiring rises ⇒
The value of Vin (the difference between the + side and the - side) becomes too small.
(The ADC input sticks to the lower limit) ⇒ Underrange

P/S	: Power supply
IDAC	: Iout Digital analog converter
MPX	: Multiplexer
AMP	: Amplifier
ADC	: Analog digital converter
μ C	: Micro controller
CLK	: Clock
FPGA	: Field programmable gate array
LED	: Light emitting diode
MCU	: Micro control unit
GND,G1	: Ground
IOA	: I/O adapter
LVDS	: Low Voltage Differential Signaling
BP	: Backplane
PE	: Protective Earth
P/C	: Photocoupler
	: Varistor
	: Resistor
	: Fuse
	: Diode
	: Capacitor

When using, please read the instruction manual attached to the product carefully and use it properly.

This catalog may not be distributed or reproduced in whole or in part without permission.

Please be aware that due to product improvements and modifications, the product description in this catalog may differ in certain respects from the actual product.

DIASYS Netmation/DIASYS Netmation4S is a registered trademark of Mitsubishi Heavy Industries, Ltd.

The service names and product names of other companies described in this catalog are the trademarks or registered trademarks of each company.