

# LSAOM01-2-R AO module

LS communication Analog outputs : 8 4 to 20 mA/0 to 20 mA

## ■ Summary

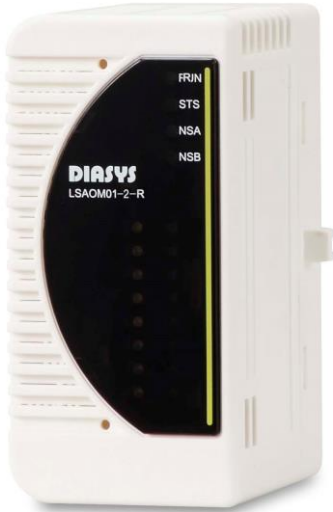

- \* Number of outputs : 8 (Channel individual isolation )
- \* Output range : 4 to 20 mA/0 to 20 mA (Selectable)
- \* Resolution : 16 bits
- \* Module ambient temperature : 0 to 55°C
- \* Isolation : Transformer insulation
- \* Supported FXtoLS adapter : LSRLTS-AI01, LSRLTS-AO01



This module is dedicated to compact retrofit terminal blocks.  
Dedicated lock pins are attached to the bottom.

# LSAOM01-2-R AO module

LS communication Analog outputs : 8 4 to 20 mA/0 to 20 mA

## ■ Specifications





ITEM		SPECIFICATION
Output	Number of channels	8 (Channel individual isolation)
	Range	4 to 20 mA/0 to 20 mA (Switchable by EMS setting) (Full Scale)
	Resolution	16 bits
	Minimum external impedance	24.9 Ω
	Maximum external impedance	750 Ω
	Switching time of the redundant configuration	2 ms
Data refresh cycle		5 ms /All channels
Operation cycle usable in DPS		10 msec or more
Absolute accuracy	@25°C	±0.1% FS
Temperature drift	@-5 to 60°C	Less than ±100 ppm/°C (relative to full-scale)
Input filter		Software digital filter (Channel individual)
Dielectric strength		AC 500 V input terminal – between PE Between input channels
Communication with IOA	Communication method	LVDS
	Communication speed	100 Mbps
HART communication compliant Between actuators Communication specification	Communication method	HART communication (superimposed on 4 to 20 mA signal)
	Communication speed	1200 bps
Self-diagnostic functions		Power voltage check (24 V, 3.3 V, 2.5 V, 1.8 V, 1.0 V) Clock check (FPGA-MCU for diagnosis, MCU for diagnosis -FPGA) Read-back error check (Presence or absence can be set by configuration) CRC check (FPGA) Tuning check ADC abnormal check
Detective		I/O signal range check (Range over, Range under) Disconnection detection (Settable of possible/none by the configuration)
Protection	(Power supply protection)	Overvoltage protection Overcurrent protection
Indicator	Display LED	4: RUN (Run) / STS (Status) / NSA (Network status A) / NSB (Network status B)
Insulation method		Transformer insulation
Hot swap		Possible
Power supply		DC 24 V ±20% (The voltage supplied from the backplane)
Environmental conditions	Module ambient temperature	(Operating) 0 to 55°C (Storage) -40 to 85°C
	Module ambient humidity	(Operating / Storage) Less than 95% RH (No condensation)
Vibration		3.5 mm @5 to 8.4 Hz 1 G @8.4 to 150 Hz
Shock		15 G 11 ms
Current consumption		299 mA
Weight		0.13kg
Dimensions		62 mm (D) x 94 mm (H) x 46 mm (W) (Except projection)
Standard/Directive		EN 61131-2:2007, RoHS

# LSAOM01-2-R AO module

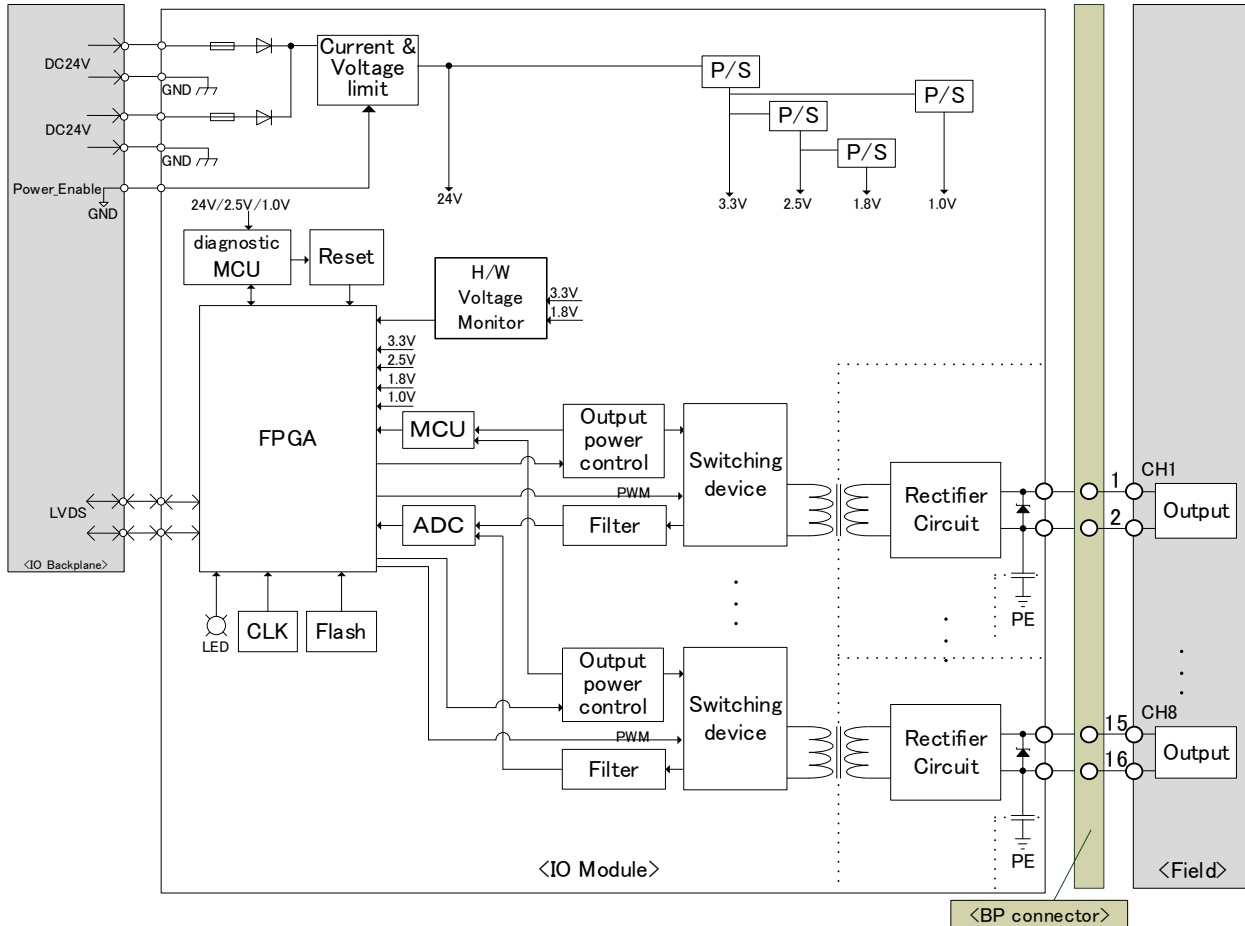
LS communication Analog outputs : 8 4 to 20 mA/0 to 20 mA

## Block diagram



P/S	:	Power supply
PWM	:	Pulse width modulation
ADC	:	Analog digital converter
CLK	:	Clock
FPGA	:	Field programmable gate array
LED	:	Light emitting diode
MCU	:	Micro control unit
GND	:	Ground
IOA	:	I/O adapter
LVDS	:	Low Voltage Differential Signaling
BP	:	Backplane
PE	:	Protective Earth
	:	Zener diode
	:	Fuse
	:	Diode
	:	Capacitor
	:	Transformer

When using, please read the instruction manual attached to the product carefully and use it properly.

This catalog may not be distributed or reproduced in whole or in part without permission.

Please be aware that due to product improvements and modifications, the product description in this catalog may differ in certain respects from the actual product.

DIASYS Netmation/DIASYS Netmation4S is a registered trademark of Mitsubishi Heavy Industries, Ltd.

The service names and product names of other companies described in this catalog are the trademarks or registered trademarks of each company.